

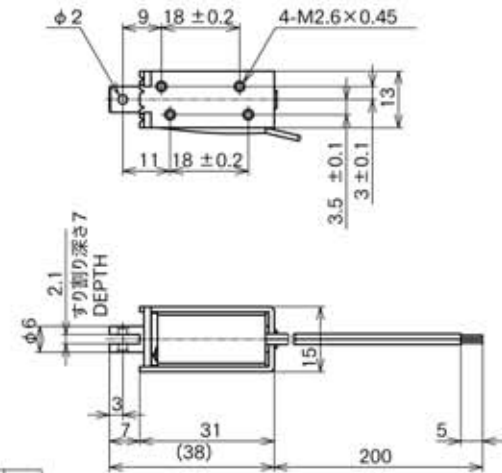

外形寸法
Dimensions

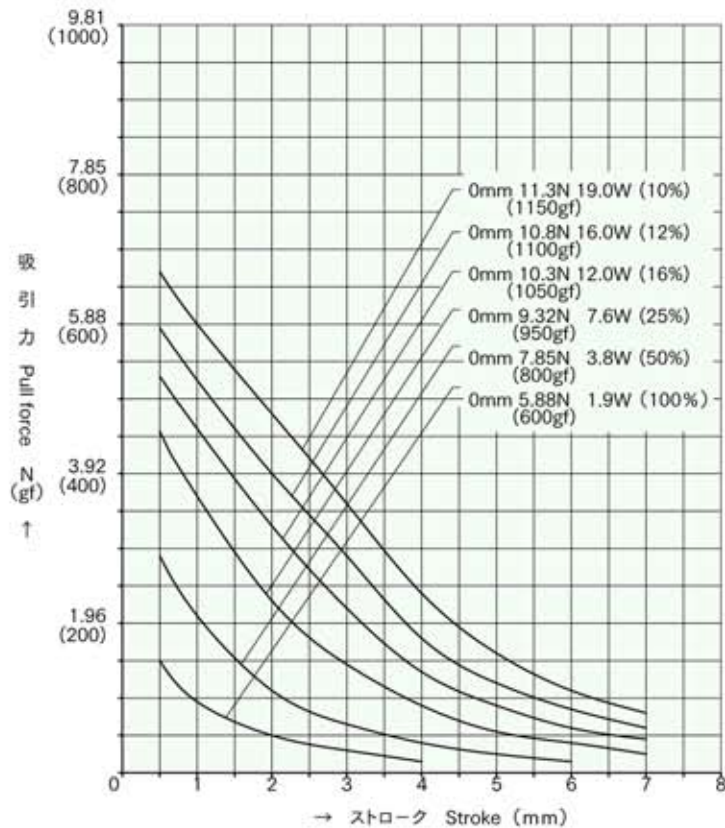

■ ストローク / 吸引力特性
Stroke and Pull Force Characteristics



■ 容量 / 吸引力特性
Power and Pull Force Characteristics

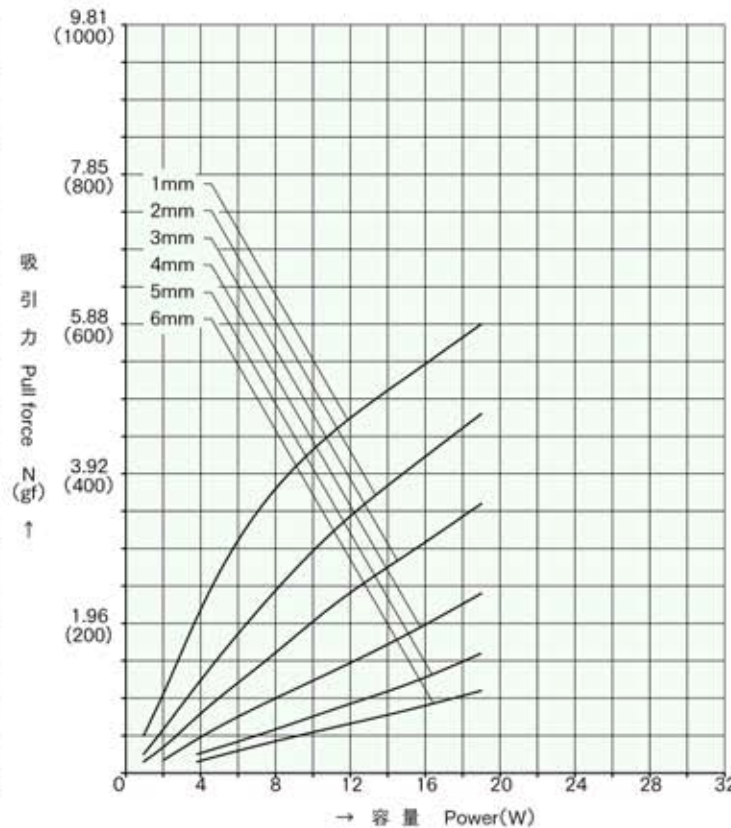

標準コイル表 連続定格 1.9W
Standard Coil Specifications
Cont. rating 1.9W

電圧 (V) Voltage	抵抗 (Ω) Resistance	電流 (mA) Current
6	19	316
12	76	158
24	303	79.2

- 総重量: 27.5g
Total weight
- プランジャー重量: 5.1g
Plunger weight