

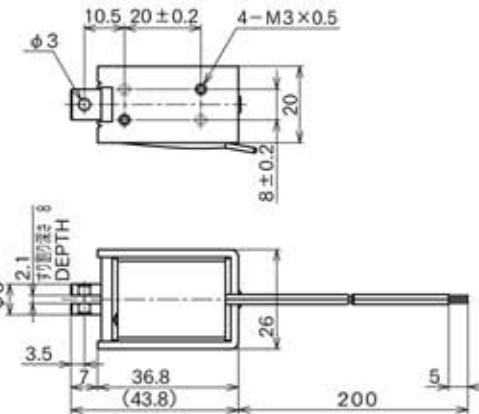

外形寸法
Dimensions

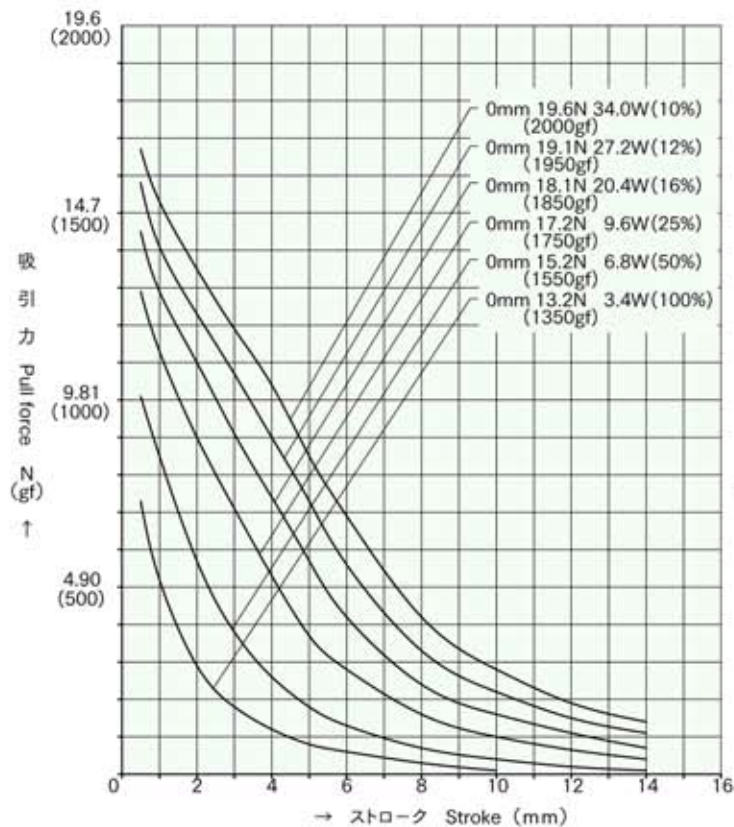

■ ストローク / 吸引力特性
Stroke and Pull Force Characteristics



■ 容量 / 吸引力特性
Power and Pull Force Characteristics

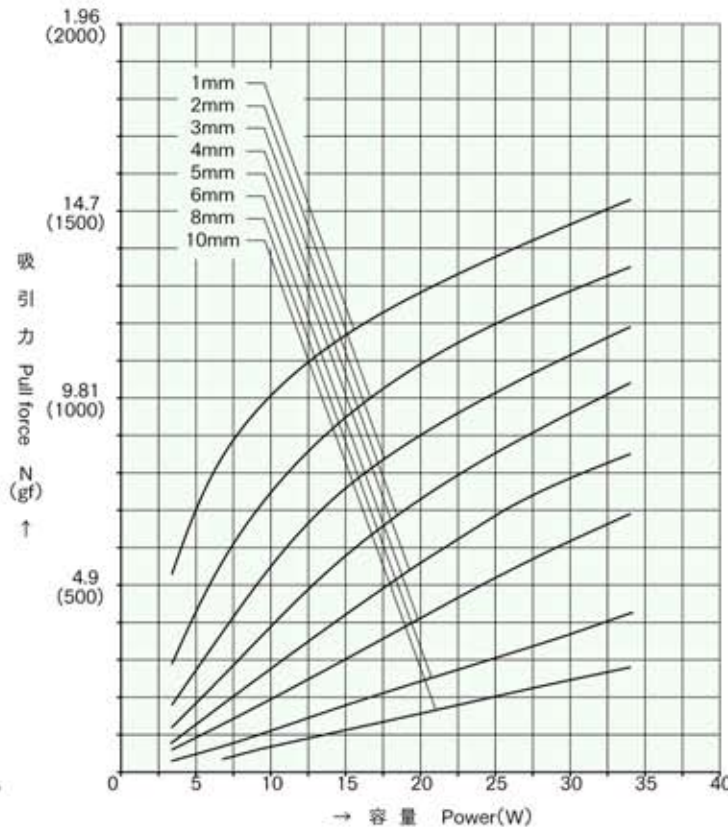

標準コイル表 連続定格 3.4W
Standard Coil Specifications
Cont. rating 3.4W

電圧 (V) Voltage	抵抗 (Ω) Resistance	電流 (mA) Current
6	10.6	566
12	42	286
24	169	142

- 総重量 : 82.0g
Total weight
- プランジャー重量 : 12.0g
Plunger weight